

# FlowGrid for axial and centrifugal fans.

Less noise – more quality of life.

# ebmpapst

The engineer's choice



Innovating for people.

**FlowGrid stands for ...**

*efficient noise protection features in cooling, ventilation and air-conditioning technology. ebm-papst offers a future-oriented solution for the problem of high-performance technology generating disturbing noise: FlowGrid for axial and centrifugal fans. The grille on the air-inlet side drastically reduces the noise emissions and minimises disturbing low frequency tones.*

There are often problems wherever people and technology share space. The movement of air, for example, often goes hand in hand with noise. With FlowGrid, noise-generating disturbances in the fan inflow are a thing of the past!

Whether it's heat pumps in the garden, supermarket condensers or ventilation systems on an industrial estate: FlowGrid, the innovative air-inlet grille from ebm-papst, combines high technical performance with drastic noise reduction.



**FlowGrid**

by **ebmpapst**  
patent pending



# Noise disturbance – cause and solution.

## Situation.

Excess noise is the result of the inflow of air to a fan being disturbed. Asymmetrical suction conditions, such as the walls of a device being at different distances from the fan, create powerful vortices. In the narrowest areas, these combine to form so-called vortex strings. These turbulences then hit the rotating blades of the fan, generating noise – specifically a broadband noise and additional narrowband, tonal frequency components, known as propeller noise or tonal noise.

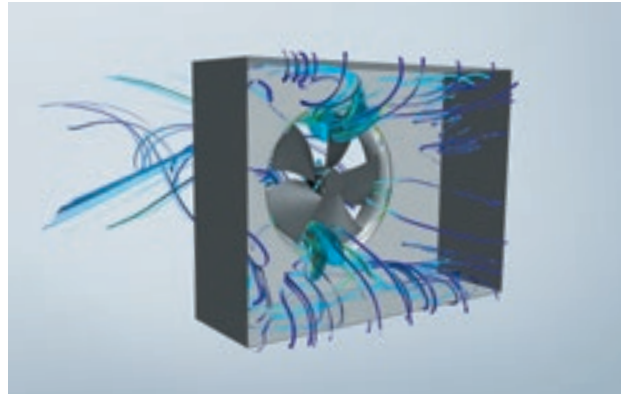

Formation of air vortices due to an asymmetrical intake area.

## Noise spectrum.

The tonal noise consists of the blade-passing noise and its harmonics. The frequency of the blade-passing noise can be calculated as the sum of the fan speed and the number of blades. The harmonics of the blade-passing noise are integer multiples of it. An axial fan with five blades and 1,200 rpm, for example, would result in a blade-passing noise with a frequency of 100 Hz. The respective frequency of the blade-passing noise and its harmonics result in high elevations in the sound pressure level, especially in the low-frequency range. But it is exactly this level where it is particularly difficult to reduce noise. Passive noise-reduction measures often mean large space requirements and high costs.

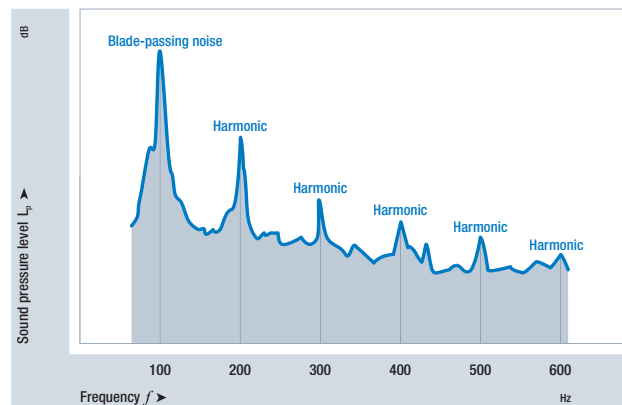

The noise spectrum is characterised by narrowband, tonal frequency components – tonal noise.

## Solution.

FlowGrid, the grille on the air intake side, drastically reduces the noise-generating disturbances. The vortex strings are split when hitting the grille and considerably weakened as they flow through it. This reduces the sound pressure in the entire frequency range, but particularly the disturbing low frequency tonal range. The result is a considerably lower sound pressure level and a noise which is less disturbing. This means that noise regulations can be complied with more easily and the well-being of people in the direct vicinity is not affected.

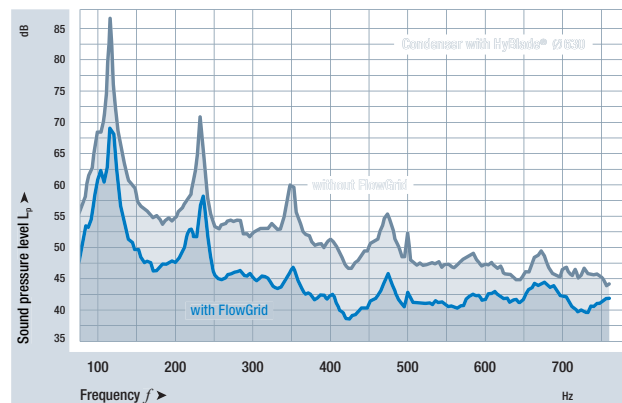





A clear improvement: FlowGrid reduces the sound pressure level and considerably weakens tonal noise.

# Less noise – proven by measurement results.

As a global player, we have to consider global issues. This also includes acting in an environmentally-conscious way. An important part of this is the reduction of noise, which plays a major role in regard to general quality of life. With FlowGrid, ebm-papst is making a clear contribution to active noise reduction. The innovative air-intake grilles work with both axial and centrifugal fans whilst

not affecting their high efficiency in any way. Using them can help to reduce or entirely avoid the use of cost-intensive, passive noise-reduction measures. It is no surprise then that FlowGrid has a patent pending. The measurement results detailed below show the benefits that FlowGrid can offer.

## Radial applications

Low profil air handling unit with RadiPac Ø 250	Air purifier with RadiCal Ø 310	Air-water heat pump with RadiCal Ø 450	Central air handling unit with RadiCal Ø 630
			
<p><b>Function</b> Ventilation and aeration of rooms, with or without heat recovery.</p> <p><b>Design</b> The spaces to be air-conditioned are supplied with conditioned air via ducts. The sound is carried through the ducts into the rooms, requiring the use of additional noise-reduction measures such as acoustic insulation.</p> <p><b>Challenge</b> Noise reduction regulations must be complied with. Furthermore, the disturbing tonal noise should be prevented from entering the rooms.</p> <p><b>Benefits of FlowGrid</b> Reduction of the noise level by 2.5 dB(A) and of the blade-passing noise by 9 dB. Acoustic insulation costs can be greatly reduced.</p>	<p><b>Function</b> Creating a comfortable climate through purifying the air from allergens and dust particles.</p> <p><b>Design</b> The fan is installed in a housing with a filter for airborne material.</p> <p><b>Challenge</b> The air inflow is disturbed by the filter on the intake side and by the limited installation dimensions. As the devices are mostly installed in areas where people live or spend long periods of time, reducing noise emissions plays an important role.</p> <p><b>Benefits of FlowGrid</b> Reduction of the noise level by 2.8 dB(A) and of the blade-passing noise by 10 dB. This leads to a comfortable climate without any disturbing operating noises.</p>	<p><b>Function</b> Heat is extracted from the outside air. This is used to heat the residential building via a circulatory system.</p> <p><b>Design</b> The centrifugal fan is installed in a housing directly behind an evaporator.</p> <p><b>Challenge</b> In compact heat pumps, the evaporator is placed very close to the fan. Excess noise is created by the disturbed air inflow. As they are used in residential buildings, however, noise limit values need to be complied with.</p> <p><b>Benefits of FlowGrid</b> Noise limit values are complied with and the blade-passing noise is reduced by 4 dB. This results in less disturbing noise.</p>	<p><b>Function</b> Central ventilation and aeration of rooms, with or without heat recovery and outside air treatment.</p> <p><b>Design</b> Apart from the fans, components such as filters, heat exchangers, humidifiers and de-humidifiers are installed in the device. The fans press air through the device and then through ventilation ducts.</p> <p><b>Challenge</b> Significant turbulences at the fan inlet, due to low distances between the fan and the walls in the intake area, as well as components of the device, impede the flow of air.</p> <p><b>Benefits of FlowGrid</b> Reduction of the noise level by 3.3 dB(A) and of the blade-passing noise by 9 dB, reducing the need for acoustic insulation.</p>
<p>-2.5 dB(A)</p> <p>-9 dB</p>	<p>-2.8 dB(A)</p> <p>-10 dB</p>	<p>-2.5 dB(A)</p> <p>-4 dB</p>	<p>-3.3 dB(A)</p> <p>-9 dB</p>
<p>Δ-Sound power level    Δ-Blade-passing noise sound pressure level</p>		<p>All examples were measured under laboratory conditions. The results are dependent upon the design of the units.</p>	



# The sound of silence.







## FlowGrid for axial and centrifugal fans

- + Reduced noise range**
  - Lower noise level
  - Drastically reduced tonal noise
- + Maintaining efficiency**
  - Air performance unaffected
  - No increase in input power
- + Compact design**
  - Low space requirements
  - Less acoustic insulation work
- + Quick assembly**
  - Through-holes for simple mounting
  - Customer-specific mounting on request
- + Effective environmental protection**
  - Noise reduction as an important part of environmentally friendly operation
- + Robust design**
  - Made from composite material
  - Available with fire protection class UL94-5VA



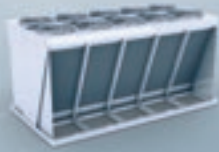

## Axial applications

Air-water heat pump with HyBlade® Ø 630	Condenser with HyBlade® Ø 710	V-shaped condenser with HyBlade® Ø 800	Condenser with HyBlade® Ø 800 and AxiTop
			
<p><b>Function</b> Heat is extracted from the outside air. This is used to heat the residential building via a circulatory system.</p> <p><b>Design</b> The axial fan is installed directly behind an evaporator for horizontal or vertical air conduction.</p> <p><b>Challenge</b> In compact heat pumps, the evaporator is placed very close to the fan. Excess noise is created by the installation position. As heat pumps are used in residential buildings, however, noise limit values need to be complied with.</p> <p><b>Benefits of FlowGrid</b> Noise limit values are complied with and the blade-passing noise is reduced by 12 dB.</p>	<p><b>Function</b> Extraction of heat arising in a coolant circuit.</p> <p><b>Design</b> One or multiple axial fans extract outside air through a horizontally arranged heat exchanger.</p> <p><b>Challenge</b> The fans are placed very close to the heat exchanger. This results in the air inflow being disturbed. If multiple fans are used in one condenser, the uneven air inflow becomes stronger.</p> <p><b>Benefits of FlowGrid</b> Reduction of the noise level by 3.9 dB(A) and a huge reduction of the blade-passing noise by 16 dB. This results in much less disturbing noise.</p>	<p><b>Function</b> Extraction of heat arising in a coolant circuit.</p> <p><b>Design</b> One or multiple axial fans extract outside air through a heat exchanger arranged in V-form.</p> <p><b>Challenge</b> Due to the size of the heat exchanger, the distances between it and the fan vary greatly. This leads to turbulences being created in the intake area.</p> <p><b>Benefits of FlowGrid</b> Reduction of the noise level by 1.3 dB(A) and of the blade-passing noise by 7 dB.</p>	<p><b>Function</b> Extraction of heat arising in a coolant circuit.</p> <p><b>Design</b> Outside air is sucked through a heat exchanger. The condenser, with a horizontally arranged heat exchanger, has an axial fan with an AxiTop diffuser unit installed on the pressure side.</p> <p><b>Challenge</b> Despite an already low noise level, there is still a disturbing tonal noise.</p> <p><b>Benefits of FlowGrid</b> Additional reduction of the noise level by 2.8 dB(A) and of the blade-passing noise by 12 dB.</p>

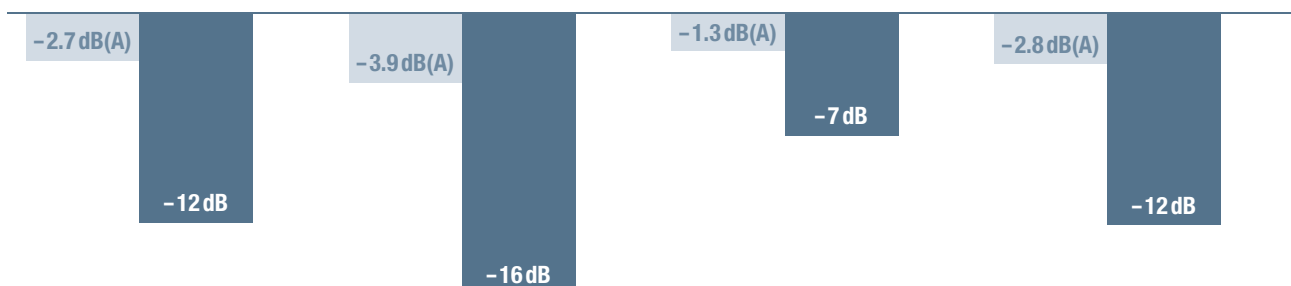

# FlowGrid – always a good solution.

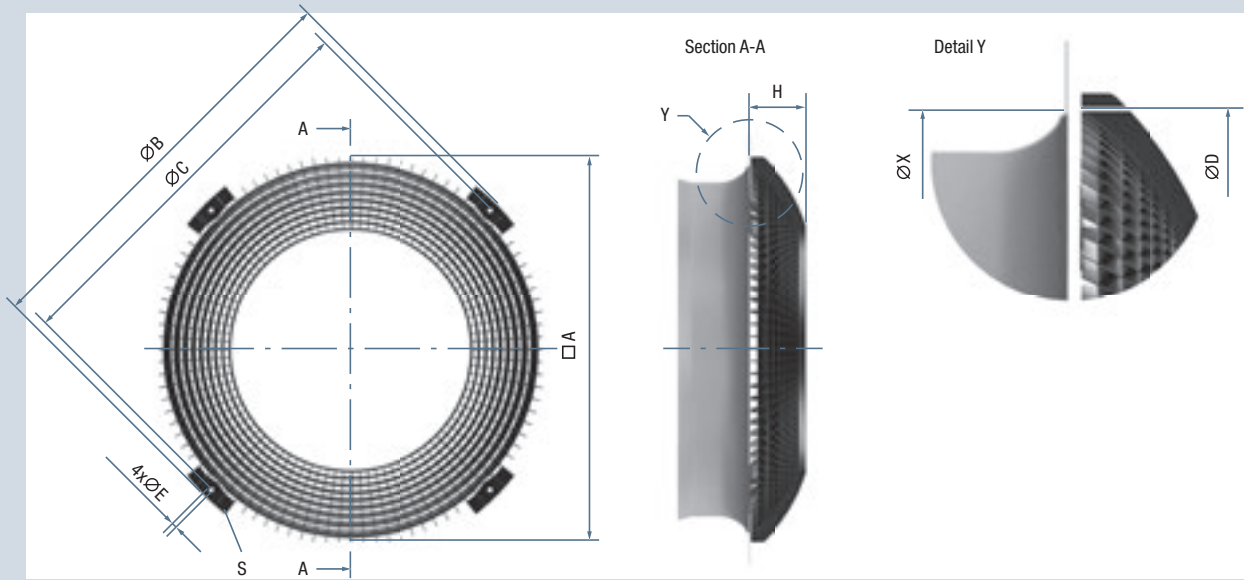

Item no.	RadiCal	RadiPac	HyBlade®	A	B	C	D	E	S	H
00190-2-2957*	175, 190	–	–	–	170	155–160	150	4.5	2.0	30
00250-2-2957*	220,225,250	–	–	–	205	193	187	4.5	2.0	38
20280-2-2957	220, 225, 250, 280	280	200	–	275	245–260	245	4.5	2.0	40
25310-2-2957	310	310	250	–	306	290	282	5.5	2.0	49
00400-2-2957	355, 400	355	–	–	350	335–345	325	5.5	2.5	60
35505-2-2957	450, 500	400, 450, 500	300, 315, 330, 350	–	465	440	412	10	2.5	71
00630-2-2957	560, 630	560, 630	400	–	565	545	532	10	3.0	90
50710-2-2957	–	710	450, 500	590	666	630	580	10	3.0	106
63000-2-2957	–	800	560, 630	734	785	750	724	10	3.0	125
80000-2-2957	–	900	710, 800	930	995	960	920	10	3.5	131
91000-2-2957	–	–	910	1,035	1,105	1,075	1,025	10	3.5	161

A: Minimum installation dimension  
 B: Outer diameter  
 C: Pitch circle diameter  
 D: Reference diameter for matching with the nozzle  
 E: Hole diameter  
 S: Thickness of fixing attachment  
 H: Installation height

X: Nozzle diameter at bent outer end

\*FlowGrid is completely enclosed and works as a guard grille

The reference diameter must be at least equal to the nozzle diameter at the bent outer end ( $D \geq X$ )

All dimensions in mm

**ebm-papst GRUPPE**  
**Mulfingen GmbH & Co. KG**

Bachmühle 2  
74673 Mulfingen  
Germany  
Phone +49 7938 81-0  
Fax +49 7938 81-110  
[info1@de.ebmpapst.com](mailto:info1@de.ebmpapst.com)

**ebmpapst**

The engineer's choice